

wagraf®

OD 1957 ROKU

KATALOG
PRODUKTÓW

2018



wagraf®

**NOWY
PRODUKT**

Szanowni Państwo.

Przedstawiam Państwu nasz **nowy produkt:**

Automat stemplarski okrągły *fi 20*,

który wprowadziłem do sprzedaży
z dniem 3 października 2017.

W nowym automacie *fi 20*
istnieje możliwość stosowania
tuszonek suchych i nasączonych
w 5 różnych kolorach:

czarnym, **fioletowym**, **niebieskim**,
zielonym lub **czerwonym**.



Mam nadzieję, że nasz nowy produkt
spełni oczekiwania Państwa i Państwa klientów.

Łączę wyrazy szacunku.

Krzysztof Popławski



wagraf®

Automaty samotuszujące POLAN, PIAST e-3, WAGRAF b	2
Tuszownice wymienne	5
Automaty samotuszujące okrągłe Fi 20, 30 i 40 datownik Fi D40	6
Datowniki automatyczne plastikowe szkieletowe	8
Automaty samotuszujące plastikowe szkieletowe	9
Automaty samotuszujące metalowe HUZAR	10
Pudełka metalowe	12
Pudełka plastikowe	13
Datowniki automatyczne plastikowe DATUŚ	14
Datowniki automatyczne metalowe WAGRAF HUZAR	14
Uchwyty plastikowe do stempli	16
Poduszki	18
Materiały eksploatacyjne do stempli polimerowych i laserowych	19
Pieczałka w 5 minut – stempel preink automaty samotuszujące pudełka plastikowe	21
Materiały eksploatacyjne do stempli preink	23
Maszyny do naświetlania	24

Automaty samotuszujące

POLAN

POLAN 1s	Compact	28x12mm
POLAN 2		39x15mm
POLAN 2s	Compact	39x15mm
POLAN 3		48x19mm
POLAN 3s	Compact	48x19mm
POLAN 4		59x25mm
POLAN 4s	Compact	59x25mm



POLAN 1s



28x12mm



POLAN 2



POLAN 2s

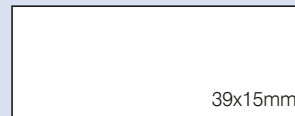

39x15mm



POLAN 3



POLAN 3s

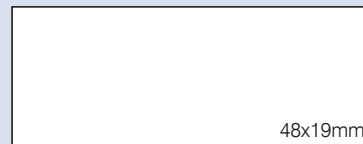

48x19mm



POLAN 4



POLAN 4s

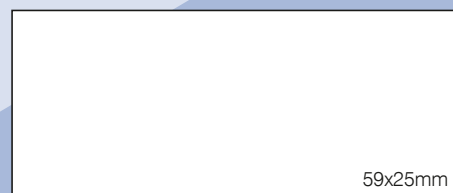

59x25mm

PIAST e-3



PIAST e-3



PIAST e-3s

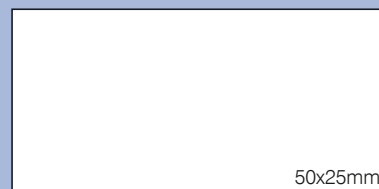

50x25mm

PIAST e-3		50x25mm
PIAST e-3s	Compact	50x25mm

POLAN

POLAN 5		70x26mm
POLAN 5s	Compact	70x26mm
POLAN 55		42x34mm
POLAN 6		69x29mm
POLAN 6s	Compact	69x29mm
POLAN 7		60x40mm
POLAN 8		75x40mm



POLAN 5



POLAN 5s

NOWOŚĆ

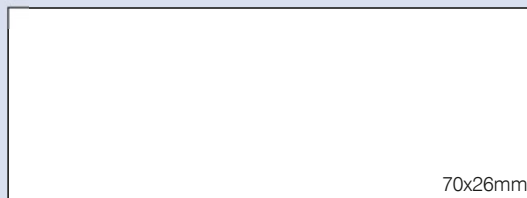

70x26mm



POLAN 55

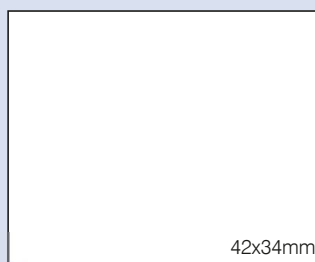

42x34mm



POLAN 6



POLAN 6s

NOWOŚĆ

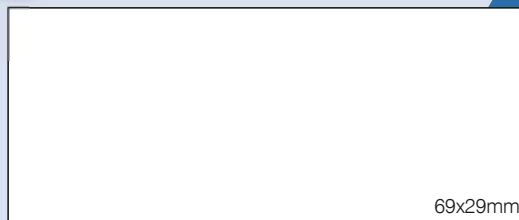

69x29mm



POLAN 7

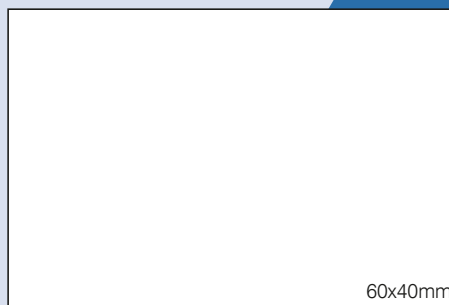

60x40mm



POLAN 8

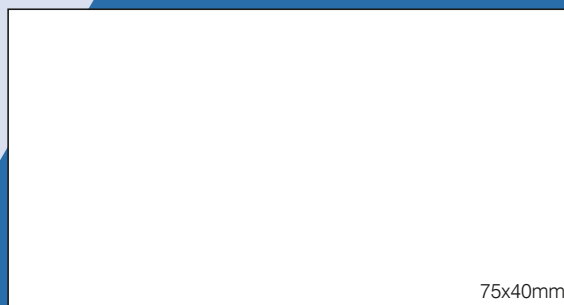

75x40mm

duża pieczętka

Automaty samotuszujące

WAGRAF b

WAGRAF b1s	Compact	28x12mm
WAGRAF b2		39x15mm
WAGRAF b2s	Compact	39x15mm
WAGRAF b3		48x19mm
WAGRAF b3s	Compact	48x19mm
WAGRAF b4		59x25mm
WAGRAF b4s	Compact	59x25mm



WAGRAF b1s



WAGRAF b2s



WAGRAF b2



WAGRAF b3s



WAGRAF b3



WAGRAF b4s



WAGRAF b4



Tuszownice wymienne

TUSZOWNICE NASĄCZONE

tuszem w kolorach: czarny, czerwony, niebieski, zielony, fioletowy

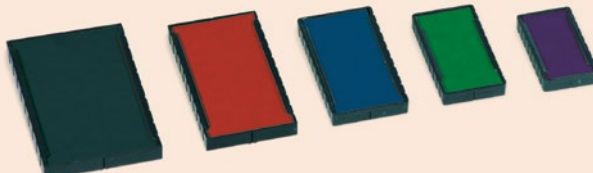
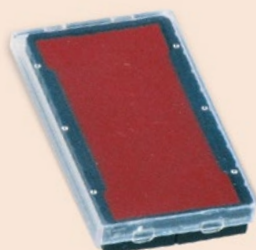

Istnieje możliwość zastosowania innego koloru tuszu do odbijania tekstu z płytki i innego do daty w datownikach POLAN D55, POLAN D7, WAGRAF D230 i D240.

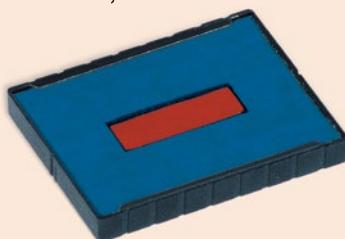

Do automatów Fi 20, Fi 30, Fi 40 i Fi D40 dostępne są tuszownice nasączone i nienasączone.

Istnieje możliwość zastosowania innego koloru tuszu do odbijania tekstu z płytki i innego do daty w datowniku Fi D40.

TUSZOWNICE NIENASĄCZONE

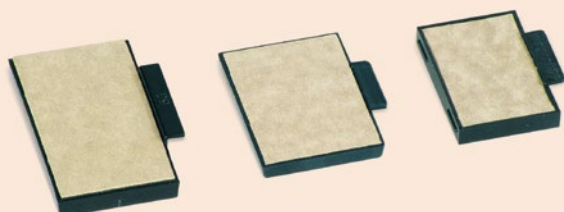

1	WAGRAF 1	28x10mm	■ ■ ■ ■ ■
2	POLAN 1 WAGRAF b1 DATUŚ	30x12mm	■ ■ ■ ■ ■
3	POLAN 2 WAGRAF b2 WAGRAF 2	38x14mm	■ ■ ■ ■ ■
4	POLAN 3 WAGRAF b3 WAGRAF 3	47x18mm	■ ■ ■ ■ ■
5	PIAST e-3	50x25mm	■ ■ ■ ■ ■
6	POLAN 4 WAGRAF b4 WAGRAF 4	58x22mm	■ ■ ■ ■ ■
7	POLAN 5	70x26mm	■ ■ ■ ■ ■
8	POLAN 55 POLAN D55	42x34mm	■ ■ ■ ■ ■
9	POLAN 6	69x29mm	■ ■ ■ ■ ■
10	POLAN 7 POLAN D7	60x40mm	■ ■ ■ ■ ■
11	POLAN 8	75x40mm	■ ■ ■ ■ ■
12	Fi 20	Ø 20mm	■ ■ ■ ■ ■
13	Fi 30	Ø 30mm	■ ■ ■ ■ ■
14	Fi 40, Fi D40	Ø 40mm	■ ■ ■ ■ ■
15	WAGRAF D230 WAGRAF 230	43x35mm	■ ■ ■ ■ ■
16	WAGRAF D240 WAGRAF 240	60x40mm	■ ■ ■ ■ ■
17	HUZAR 20	39x14mm	■ ■ ■ ■ ■
18	HUZAR 30 HUZAR D30	42x30mm	■ ■ ■ ■ ■
19	HUZAR 40	55x23mm	■ ■ ■ ■ ■
20	HUZAR 50	58x30mm	■ ■ ■ ■ ■
21	HUZAR 60	70x24mm	■ ■ ■ ■ ■
22	HUZAR 80 HUZAR D80	70x48mm	■ ■ ■ ■ ■
23	WAGRAF 100	25x42mm	■ ■ ■ ■ ■
23	HUZAR 65 HUZAR 140	58x35mm	■ ■ ■ ■ ■

paleta barw

wagraf®

Automaty stemplarskie

okrągłe *fi 20, fi 30, fi 40*

Fi 20	Compact	Ø 20mm
Fi 30	Compact	Ø 30mm
Fi 40	Compact	Ø 40mm

NOWOŚĆ



Fi 20

Ø 20mm



NOWOŚĆ



Fi 30

Ø 30mm



NOWOŚĆ



Fi 40

Ø 40mm



Datownik automatyczny plastikowy okrągły *fi* D40

Fi D40	Compact	Ø 40mm
--------	---------	--------

Dostępne są dwa rodzaje datowników Fi D40:

- miesiące pisane słownie
2018 MAR. 14
- miesiące pisane cyframi
2018-03-14

Nowość

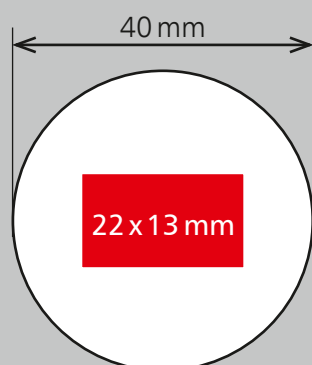

Fi D40



datuj na okrągło

Datowniki automatyczne plastikowe szkieletowe

WAGRAF D230	43x35mm
WAGRAF D240	60x40mm



NOWOŚĆ

WAGRAF D230

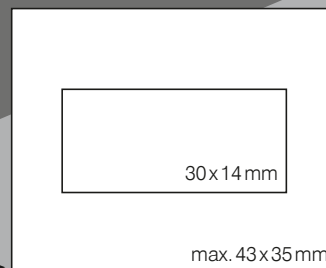

W datownikach automatycznych plastikowych szkieletowych D230 i D240 elementy plastikowe występują w 9 różnych kolorach.



NOWOŚĆ

Datowniki automatyczne plastikowe szkieletowe pozwalają na zamieszczenie w odbiciu pieczętki

- daty
- oraz tekstu dowolnej treści.

Istnieje możliwość zastosowania innego koloru tuszu do odbijania tekstu z płytki i innego do daty.

Dostępne są dwa rodzaje datowników D230 i D240:

- miesiące pisane słownie
2018 MAR. 14
- miesiące pisane cyframi
2018-03-14

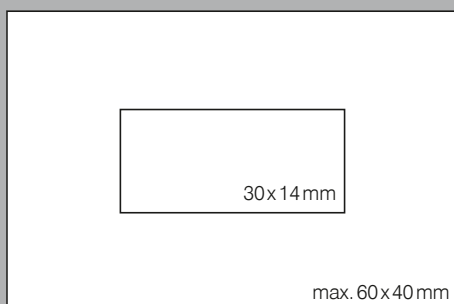

WAGRAF D240



lekkie datowanie

Automaty samotuszujące plastikowe szkieletowe

WAGRAF 230	43x35mm
WAGRAF 240	60x40mm

NOWOŚĆ



WAGRAF 230



max. 43x35 mm

W automatach samotuszujących plastikowych szkieletowych 230 i 240 elementy plastikowe występują w 9 różnych kolorach.



NOWOŚĆ



WAGRAF 240

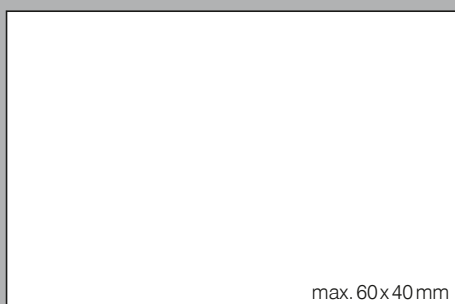

max. 60x40 mm

lekke stemplowanie

wagraf®

Automaty samotuszujące metalowe

huzar®



huzar®

39x14mm

HUZAR 20

huzar®

42x30mm

HUZAR 30



huzar®

55x23mm

HUZAR 40



huzar®

58x30mm

HUZAR 50



Huzar® to najnowszy model stempla ręcznego, zgłoszony do ochrony w Urzędzie Patentowym Rzeczypospolitej Polskiej Nr P-368177 i chroniony w krajach Unii Europejskiej i USA z ważnością od dnia 24.05.2004.



HUZAR 60

huzar®



70x24mm



HUZAR 65

huzar®



58x35mm



HUZAR 80

huzar®

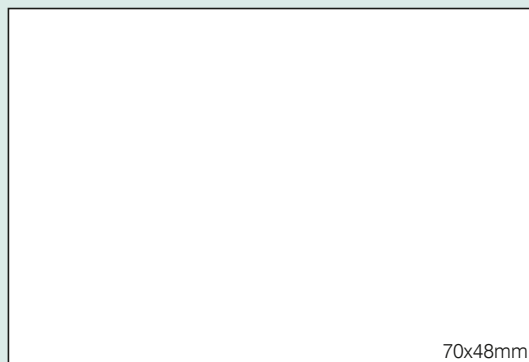

70x48mm

HUZAR 20	metalowy	39x14mm
HUZAR 30	metalowy	42x30mm
HUZAR 40	metalowy	55x23mm
HUZAR 50	metalowy	58x30mm
HUZAR 60	metalowy	70x24mm
HUZAR 65	metalowy	58x35mm
HUZAR 80	metalowy	70x48mm

Pudełka metalowe

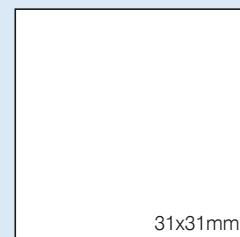
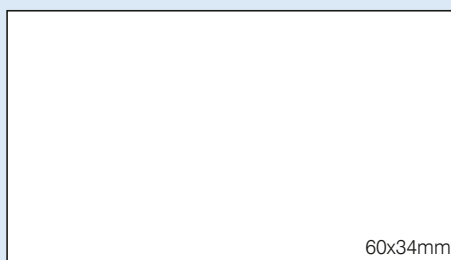
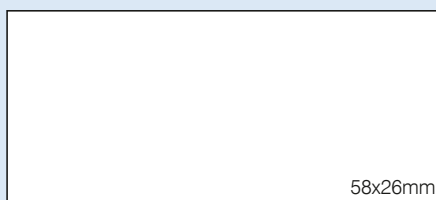
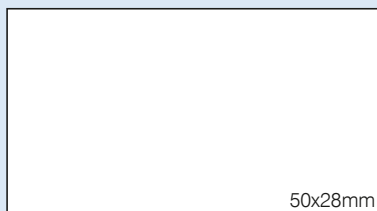
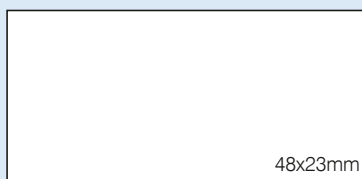
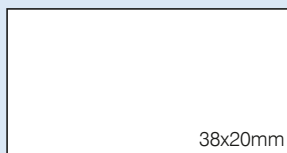
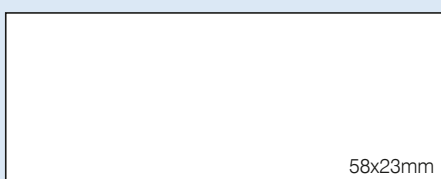
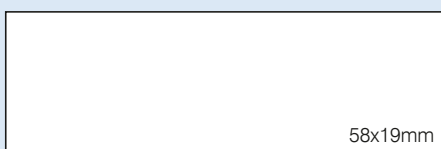
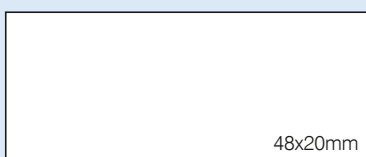
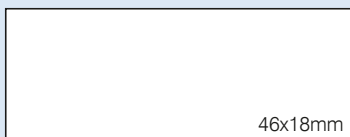
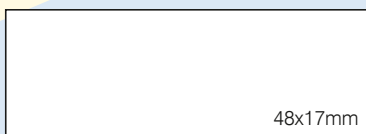
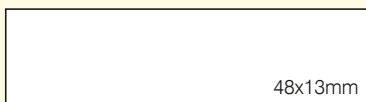
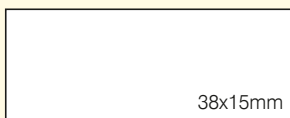

Pudełko	nr 1	38x15mm
Pudełko	nr 1,5	48x13mm
Pudełko	nr 1 3/4	38x20mm
Pudełko	nr 2 I	48x17mm
Pudełko	nr 2 II	46x18mm
Pudełko	nr 2,5	48x20mm
Pudełko	nr 2 3/4 I	48x23mm
Pudełko	nr 2 3/4 II	50x28mm
Pudełko	nr 3	58x19mm
Pudełko	nr 3,5	58x23mm
Pudełko	nr 4	58x26mm
Pudełko	nr 4,5	60x34mm
Pudełko	nr 5	50x50mm
Pudełko	nr 0	26x23mm
Pudełko	nr 01	31x31mm



Pudełka plastikowe

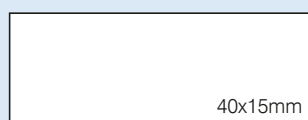
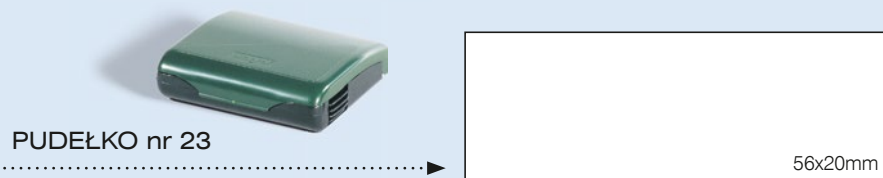
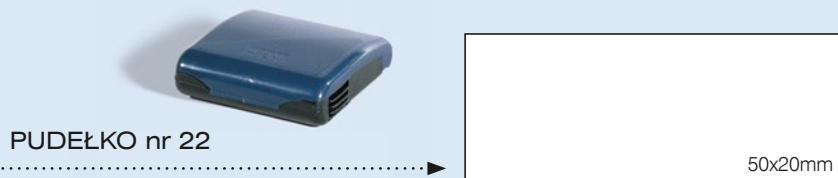

PUDEŁKO nr 27

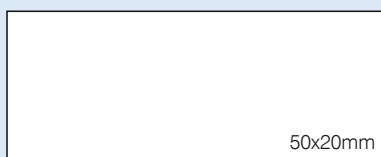

PUDEŁKO nr 28

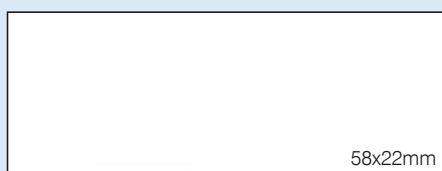

PUDEŁKO nr 29

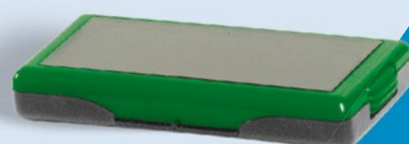

NOWOŚĆ

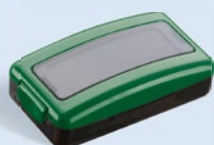

PUDEŁKO nr 33

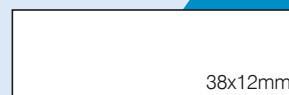

NOWOŚĆ

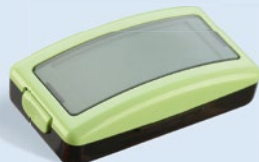

PUDEŁKO nr 34



NOWOŚĆ



PUDEŁKO nr 35



Pudełko	nr 21	40x15mm
Pudełko	nr 22	50x20mm
Pudełko	nr 23	56x20mm
Pudełko	nr 27	40x15mm
Pudełko	nr 28	50x20mm
Pudełko	nr 29	58x22mm
Pudełko	nr 33	38x12mm
Pudełko	nr 34	48x17mm
Pudełko	nr 35	59x21mm

Datowniki automatyczne plastikowe

DATUŚ	bez płytki
-------	------------



DATUŚ
bez płytki



Datowniki automatyczne metalowe

WAGRAF 100		42x25mm
WAGRAF 110	bez płytki	

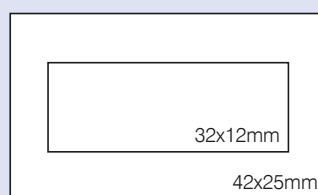

WAGRAF 110
bez płytki



HUZAR D30

huzar®

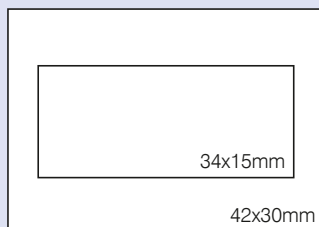

HUZAR D30	42x30mm
HUZAR 140	58x35mm
HUZAR D80	70x48mm

Datowniki automatyczne metalowe pozwalają na zamieszczenie w odbiciu pieczętki

- daty
- oraz tekstu dowolnej treści.

Istnieje możliwość zastosowania innego koloru tuszu do odbijania tekstu z płytki i innego do daty.

Dostępne są dwa rodzaje datowników metalowych:

- miesiące pisane słownie
2018 MAR. 14
- miesiące pisane cyframi
2018-03-14



HUZAR 140

huzar®

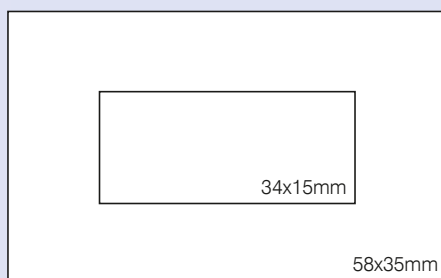

HUZAR D80

huzar®

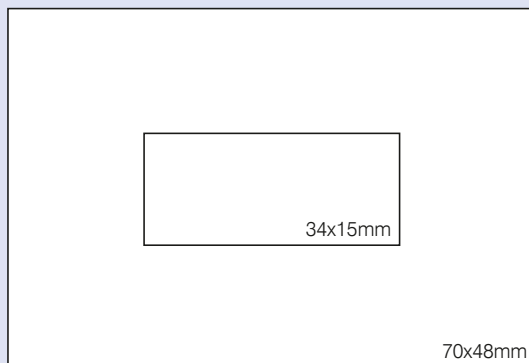

Uchwyty plastikowe do stempli



13x50mm



15x40mm



20x40mm



17x50mm



20x50mm



23x50mm

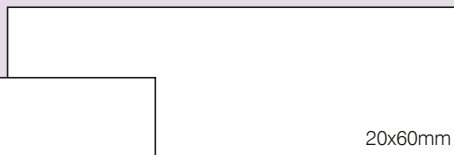

20x60mm

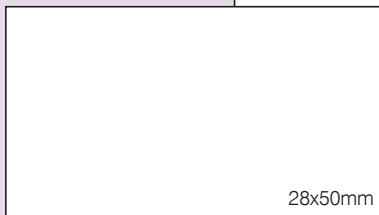

28x50mm

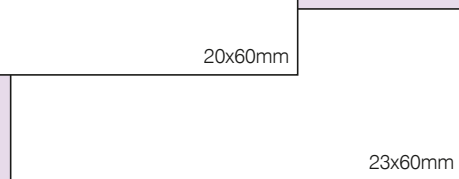

23x60mm

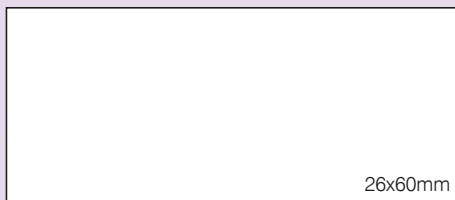

26x60mm

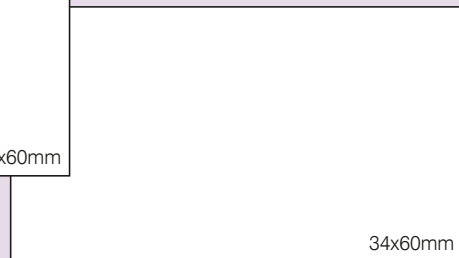

34x60mm



18x27mm

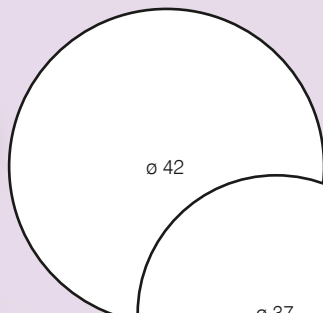

ø 42

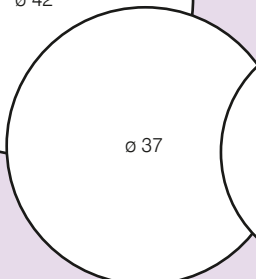

ø 37

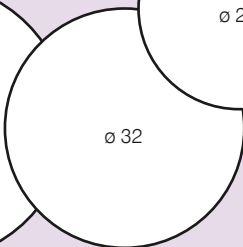

ø 32

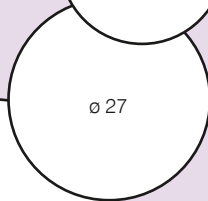

ø 27

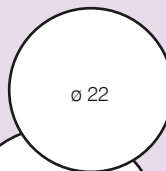

ø 22



Uchwyt	nr 1	15x40mm
Uchwyt	nr 1,5	13x50mm
Uchwyt	nr 1 3/4	20x40mm
Uchwyt	nr 2	17x50mm
Uchwyt	nr 2,5	20x50mm
Uchwyt	nr 2 3/4	23x50mm
Uchwyt	nr 2 3/4 II	28x50mm
Uchwyt	nr 3	20x60mm
Uchwyt	nr 3,5	23x60mm
Uchwyt	nr 4	26x60mm
Uchwyt	nr 4,5	34x60mm
Uchwyt	nr 0	18x27mm
Uchwyt	nr 740	7x40mm
Uchwyt	nr 745	7x45mm
Uchwyt	nr 750	7x50mm
Uchwyt	nr 755	7x55mm
Uchwyt	okrągły	ø 22
Uchwyt	okrągły	ø 27
Uchwyt	okrągły	ø 32
Uchwyt	okrągły	ø 37
Uchwyt	okrągły	ø 42
Uchwyt	nr 1040	10x40mm
Uchwyt	nr 1045	10x45mm
Uchwyt	nr 1055	10x55mm
Uchwyt	nr 1070	10x70mm



7x40mm



7x45mm



7x50mm



7x55mm



10x40mm



10x45mm



10x55mm



10x70mm

Uchwyt	nr 4075	40x75mm
Uchwyt	nr 4565	45x65mm
Uchwyt	nr 5555	55x55mm
Uchwyt	nr 5565	55x65mm
Uchwyt	nr 5575	55x75mm
Uchwyt	nr 6565	65x65mm

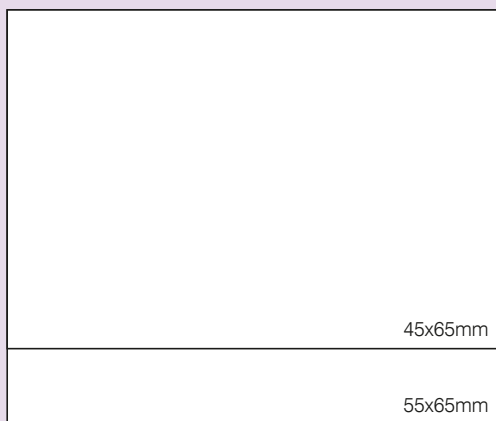
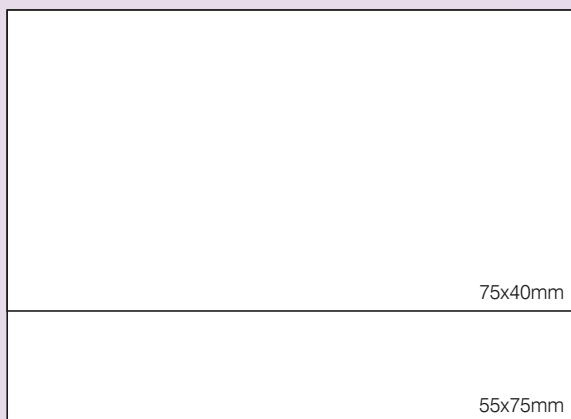

Uchwyt	nr 7090	70x90mm
Uchwyt	nr 80100	80x100mm
Uchwyt	nr 90110	90x110mm

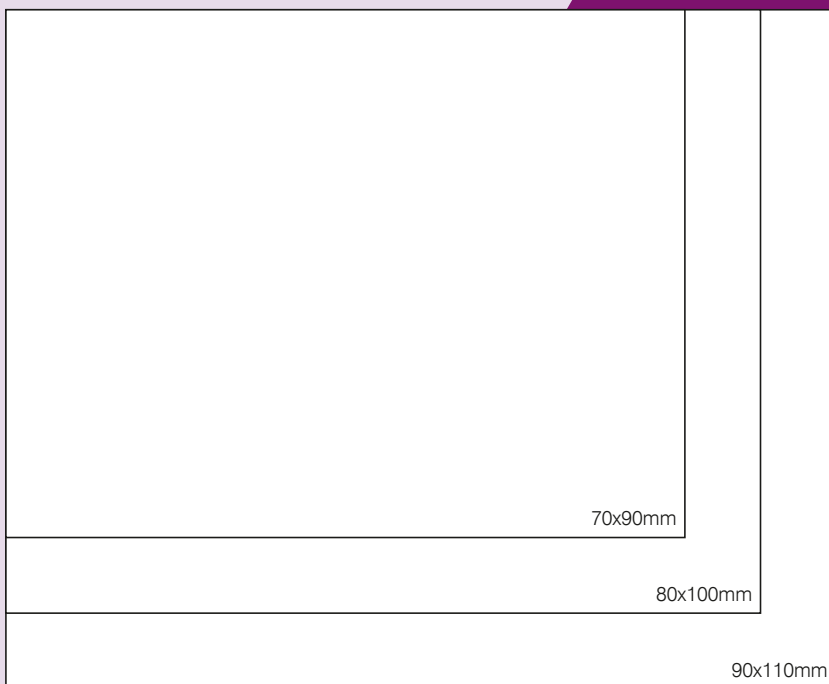
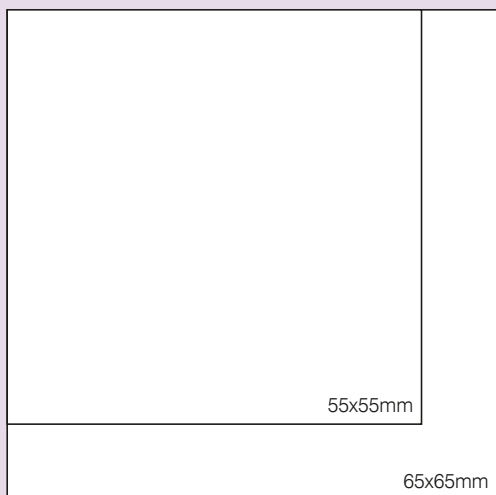

Poduszki



PM
poduszka mała (plastikowa) – 50 x 85 mm

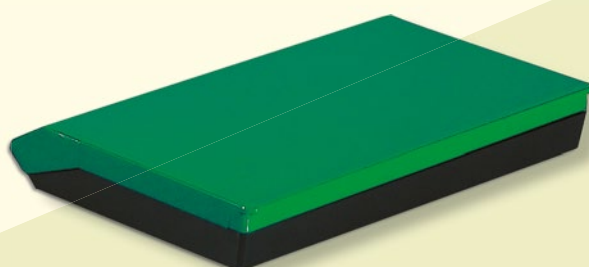

PS
poduszka średnia (plastikowa) – 70 x 110 mm

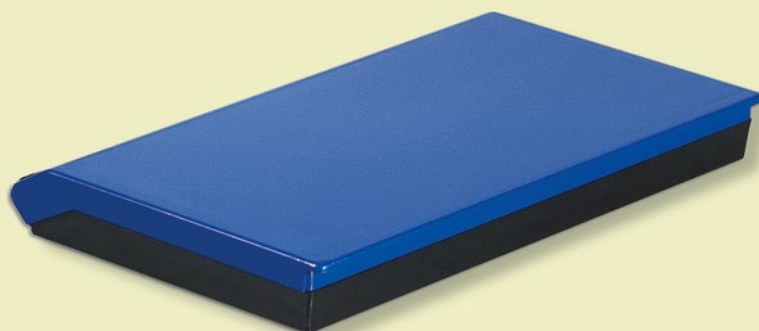

PD
poduszka duża (plastikowa) – 85 x 155 mm



PMD
poduszka metalowa duża – 190 x 110 mm

PM	50x85mm
PS	70x110mm
PD	85x155mm
PMD	190x110mm

Poduszki plastikowe
PD, PS, PM
są nasączone tuszem.

Kolor pokrywki określa
kolor tuszu (czarny, niebieski,
czerwony, fioletowy, zielony).



Poduszka metalowa PMD
– to poduszka sucha
do samodzielnego
napełniania tuszem.

Materiały eksploatacyjne do stempli polimerowych i laserowych



Fotopolimer 1 kg



Wywloczacz 1 kg



Utrwalacz 1 kg



Płyn do płukania 1 kg



Folia nośna



Folia ochronna



Kalka do wydruku, laser film



Film UV



Uszczelka (grubość 2 i 3 mm)



Tusz polimerowy 25 ml

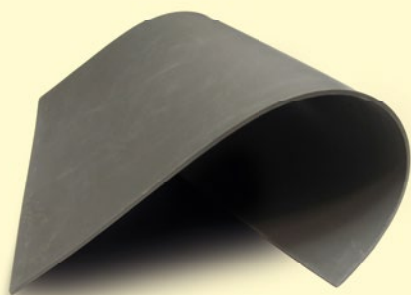

Guma do lasera

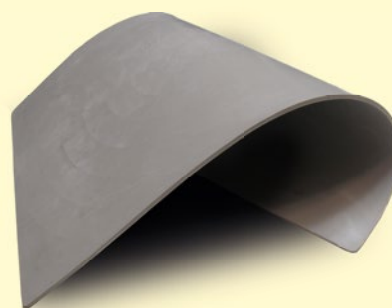

Guma do lasera ekonomiczna

Pieczętka w 5 minut Stempel preink

automaty samotuszujące

Do automatów a2, a3 i a4
dostępne są odpowiednie
materiały do naświetlania.



WAGRAF a2



40x15mm



WAGRAF a3

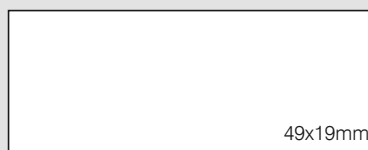

49x19mm



WAGRAF a4

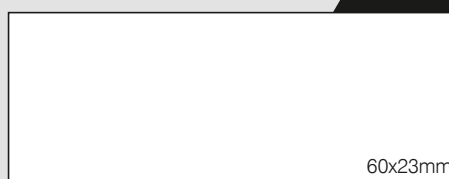

60x23mm

WAGRAF a2	preink	40x15mm
WAGRAF a3	preink	49x19mm
WAGRAF a4	preink	60x23mm



w 5 minut

Stempel preink pudełka plastikowe



PUDEŁKO nr 30	preink	40x15mm
PUDEŁKO nr 31	preink	49x19mm
PUDEŁKO nr 32	preink	60x23mm

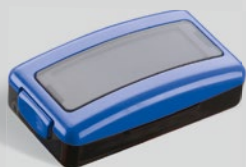

PUDEŁKO nr 30



PUDEŁKO nr 31

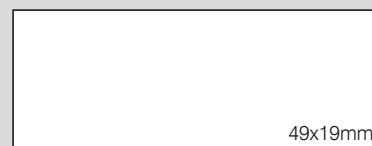

PUDEŁKO nr 32

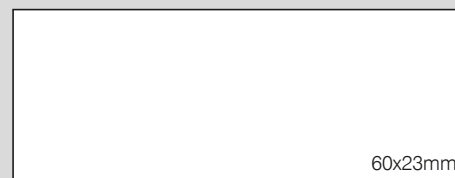

Do pudełek nr 30, 31 i 32
dostępne są odpowiednie
materiały do naświetlania.

Materiały eksploatacyjne do stempli preink



Kalka do wydruku, laser film



Folia ochronna

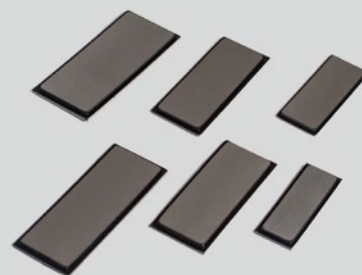

Materiał do naświetlania



Tusz do stempli w butelkach 30ml



Cartridge kolorowe do stempli

WAGRAF a2 PUDEŁKO nr 30	preink	40x15mm
WAGRAF a3 PUDEŁKO nr 31	preink	49x19mm
WAGRAF a4 PUDEŁKO nr 32	preink	60x23mm

Maszyny do naświetlania do stempli preink



MQ B1308 1 lampa



MQ B1409



MQ B1511

Maciej Kot

nasza duma!



wagraf[®]
SPONSOR
MACIEJA KOTA
www.maciejkot.com

Zakład Mechaniczny

wagraf®

**04-608 Warszawa - Anin, ul. Stradomska 56A
tel./fax 22 812 12 34, 22 815 62 83, 22 815 33 01,
22 815 63 05, 22 812 45 62, 22 815 38 53
www.wagraf.pl**

